

# **End of the Golden Weather?**

**Innovation, Trends and the Future of Synthetic and Natural Refrigerants**

It was a time when anything seemed possible  
– even miracles



An Ian Mune Film

# *The End of the Golden Weather*

based on the extraordinary play  
by Bruce Mason

 **BECA**

# Contents

- A word on safety
- Legislative Drivers
- Australia's Progress to date
- What it means for Refrigerants
- Refrigerant Options
  - Synthetic
  - Natural
- Actual real equipment
- Thinking outside the box

# Safety

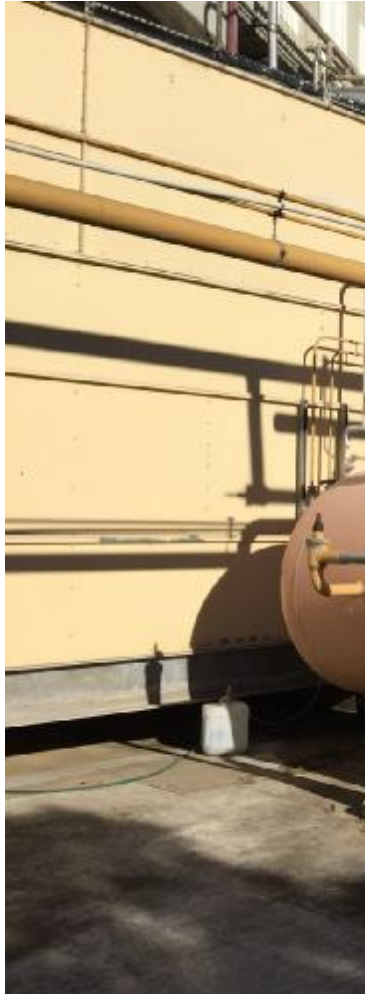

ca

# Safety

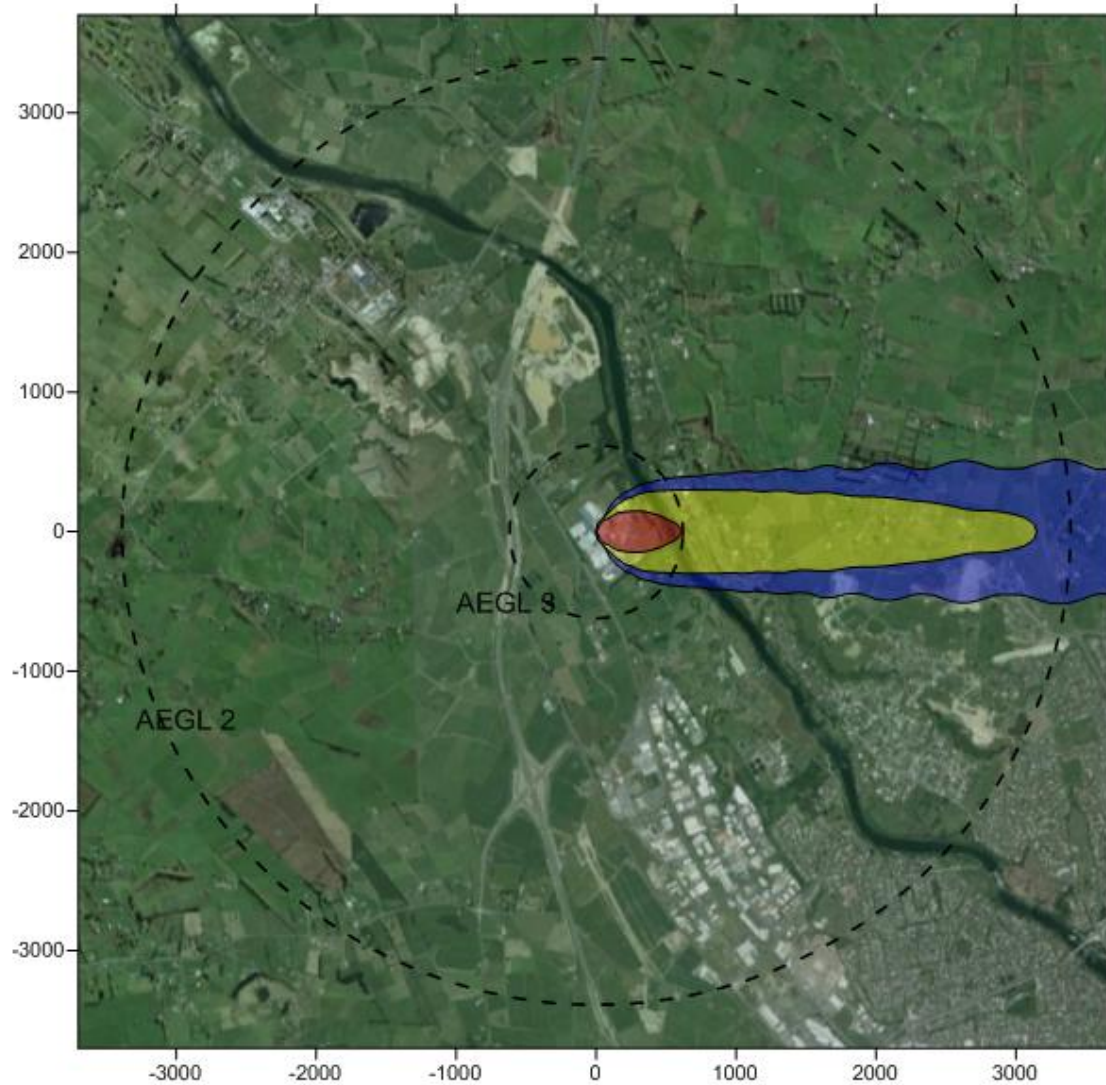

Figure 1. Predicted maximum 10-minute average ammonia concentrations for night time



# Legislation and COP21 (Paris Agreement)

Australia's target of a 26 to 28 per cent reduction in greenhouse gas emissions below 2005 levels by 2030 ***remains unchanged***, but the Paris agreement will put ***pressure on the Government to do more***.

## Reviews of reduction targets

- The deal puts in place mechanisms to review reduction targets every five years starting from 2020, which will include Australia.
- Each stocktake will have to result in a more ambitious target.
- Foreign Minister Julie Bishop conceded that would be a challenge for the Government, but that the deal would provide further "flexibility" to do more on climate change.

# The Paris Agreement – is real!

theguardian

home UK world sport football opinion culture business lifestyle fashion environment tech travel

≡ browse all sections

home › world › australia africa middle east cities development europe US americas asia

**COP 21: UN climate change conference | Paris**

Lenore Taylor on politics

## What does the Paris climate agreement mean for Australia?

Climate policy is no longer something that can be papered over, or worked around, or ignored, or used as a political attack weapon

Lenore Taylor in Paris

@lenoretaylor

Saturday 12 December 2015 18.40 GMT



Shares 2,228 Comments 644

Save for later



Coal operations at the Port of Newcastle: We will have to retire the old brown coal-fired generators and reduce industrial carbon pollution. Photograph: William West/AFP/Getty Images

urely Australia can use this Paris climate agreement to finally end the

### Most popular



Hillary Clinton emails recovered by FBI to be released just before election day

# Australia – Above the Line Behaviour!

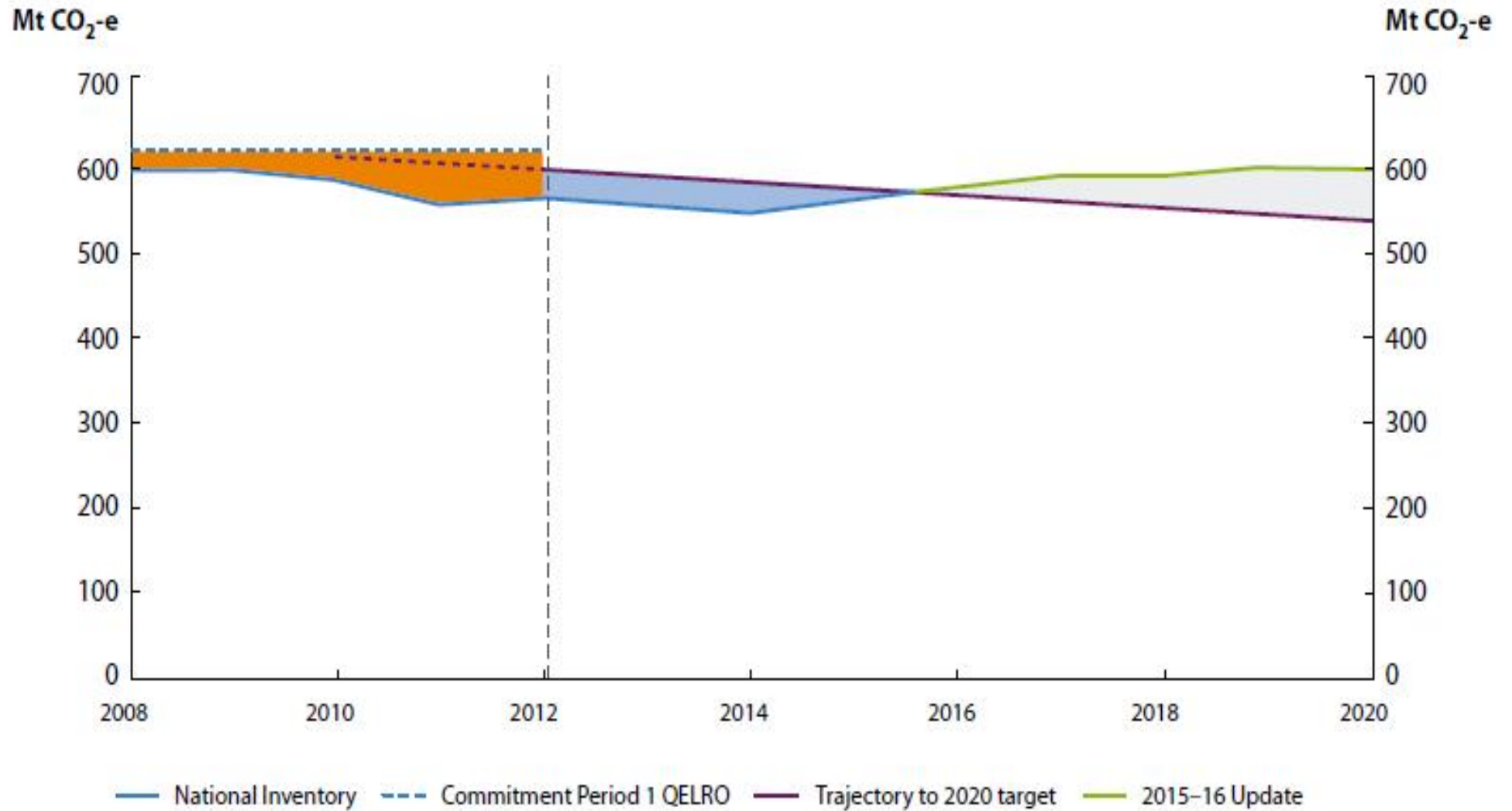

# Australia's Targets

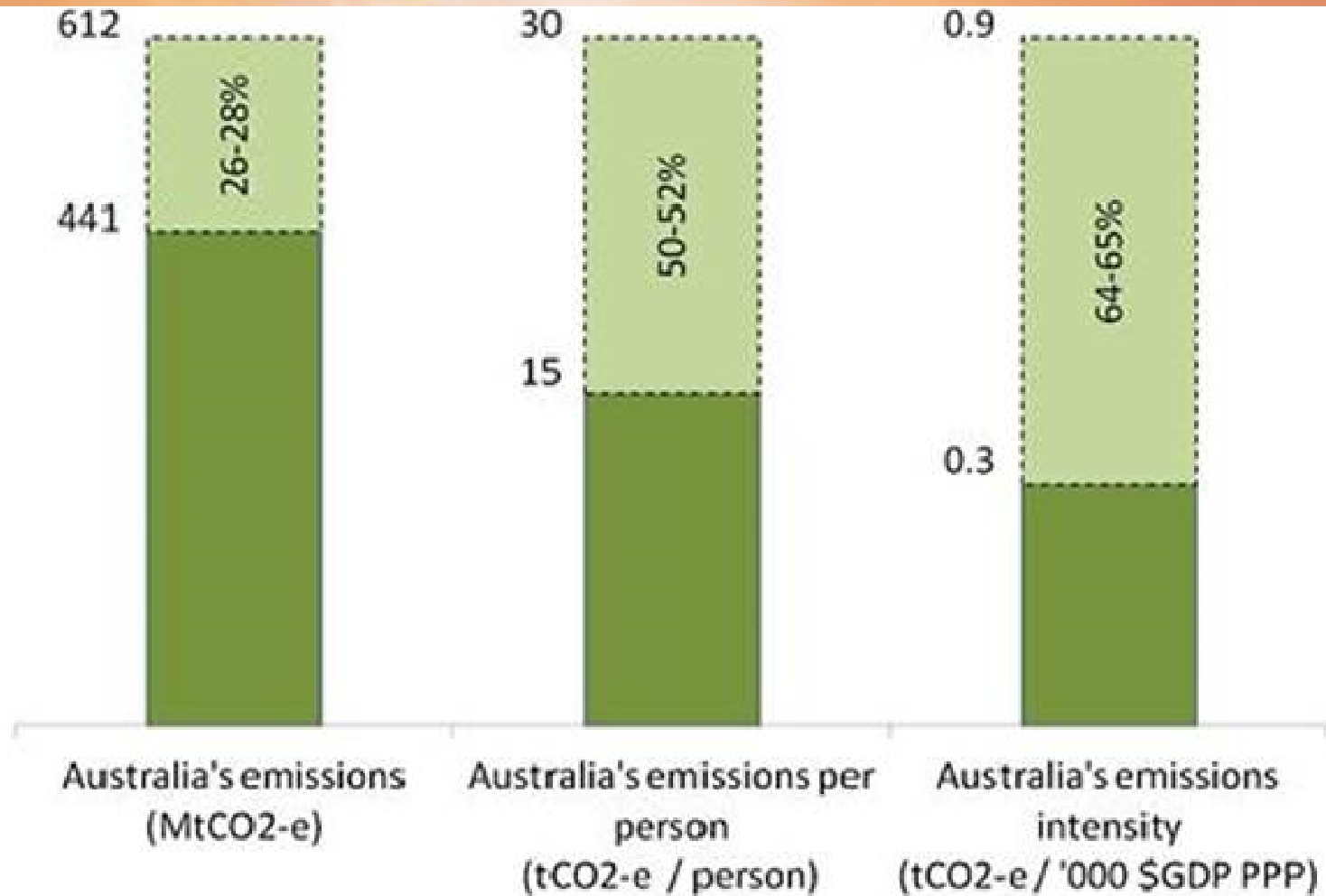

# New Synthetics – Keeping you hooked

## Opteon™ Refrigerant Options

Replaces		Opteon™ Refrigerant Solutions				Primary Applications**			
ASHRAE	GWP*	Product Name	ASHRAE #	GWP*	Class**	R	C	AC	W
HFC-134a	1430	Opteon™ XP10	R-513A	631	A1	√	√	√	
HFC-404A / 507	3922 / 3985	Opteon™ XP40	R-449A	1397	A1	√			
		Opteon™ XP44	R-452A	2140	A1	√			
HFC-407A	2107	Opteon™ XP40	R-449A	1397	A1	√			
HFC-407F	1824								
HCFC-22	1810	Opteon™ XP40	R-449A	1397	A1	√	√		

## Opteon™ Refrigerant Options—In Development

Replaces		Opteon™ Refrigerant Solutions				Primary Applications**			
ASHRAE	GWP*	Product Name	ASHRAE #	GWP*	Class**	R	C	AC	W
HFC-404A / 507	3922 / 3985	Opteon™ XL40*	R-454A	239	A2L	√			
HFC-410A	2088	Opteon™ XL41*	R-454B	466	A2L			√	
HFC-134a	1430	Opteon™ YF	R-1234yf	4	A2L	√	√	√	
HFC-410A	2088	Opteon™ XL55***	Not Yet Assigned	698	A2L		√	√	
HCFC-123	77	Opteon™ MZ*	R-1336mzzZ	9	A1		√		√
HFC-245fa	1030								

# Are we nearly there yet?

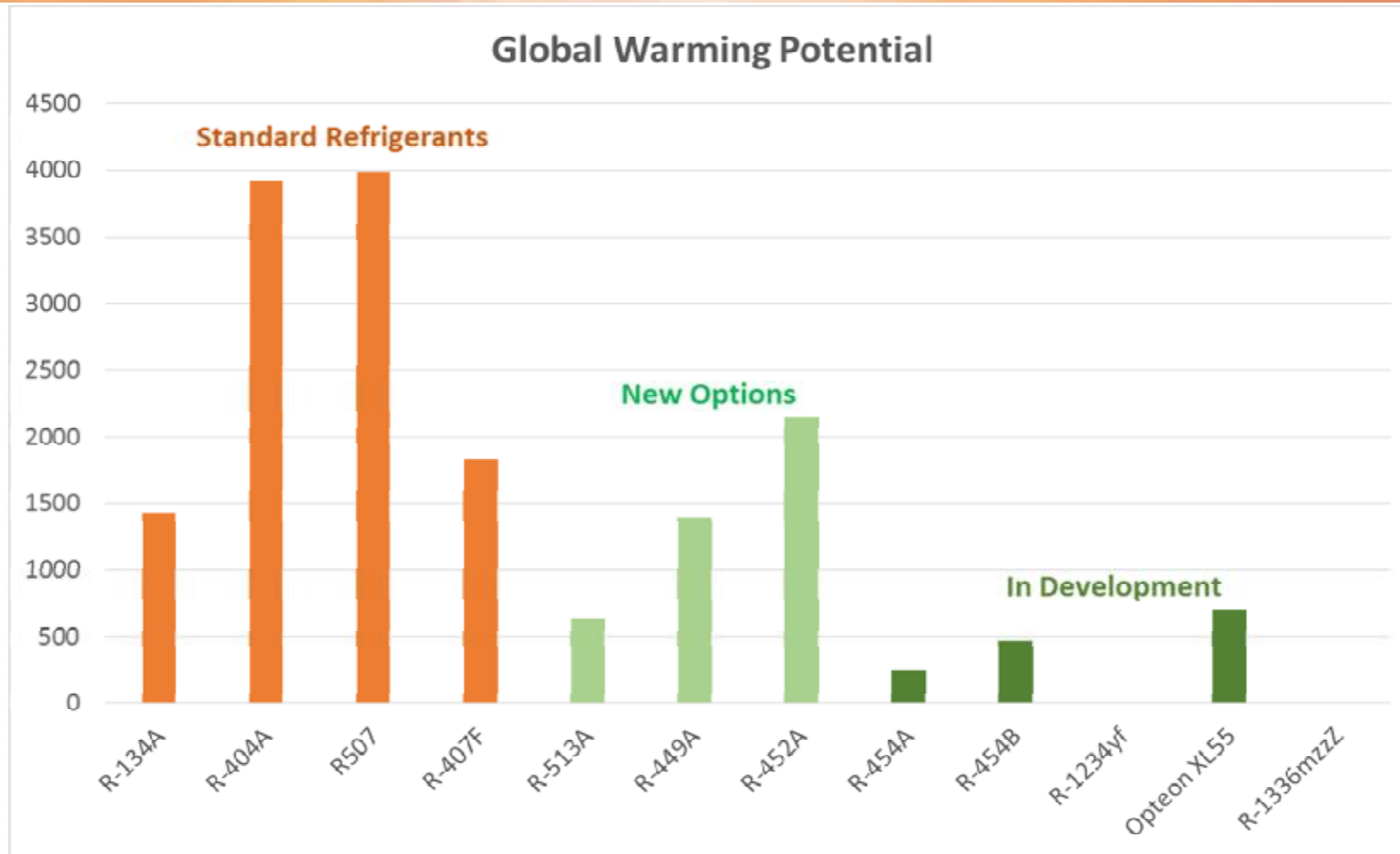

# New Synthetic Alternatives? R-513A

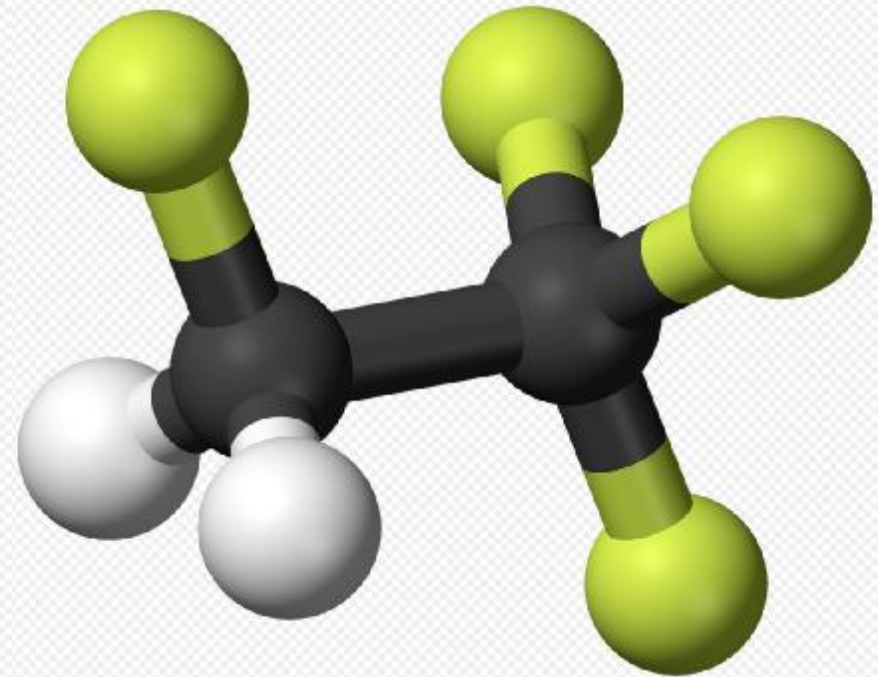
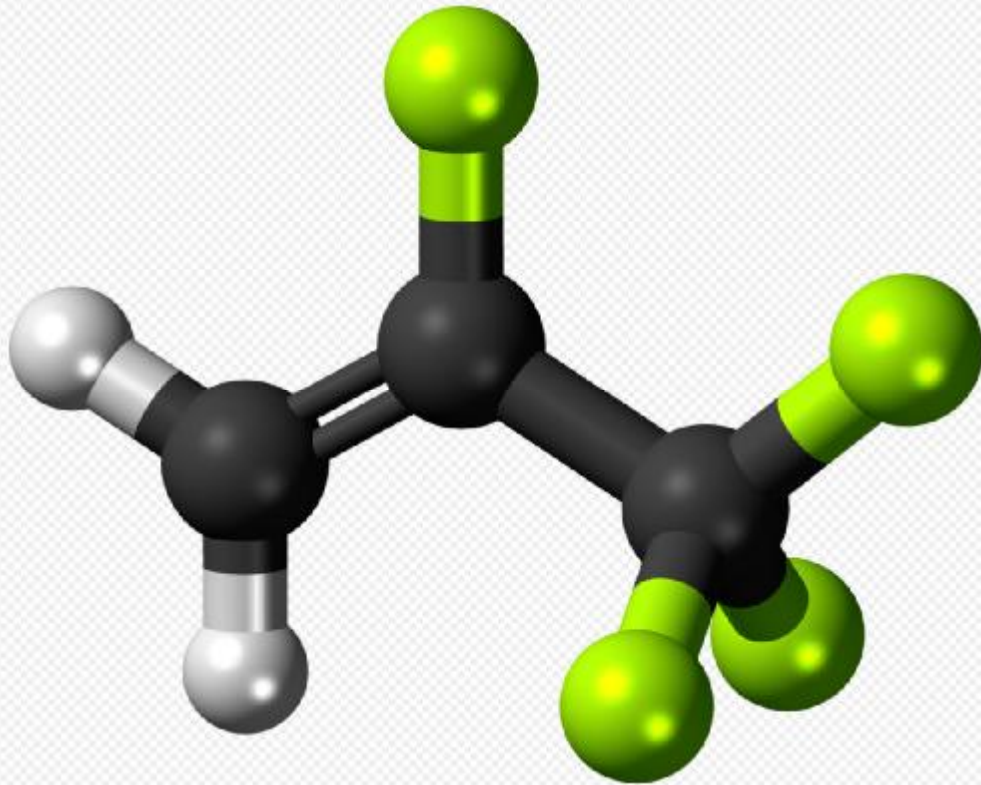

- R-513A
- A mixture of R-1234yf and R-134A
- GWP 631(!)

# Prices Increases for the foreseeable future

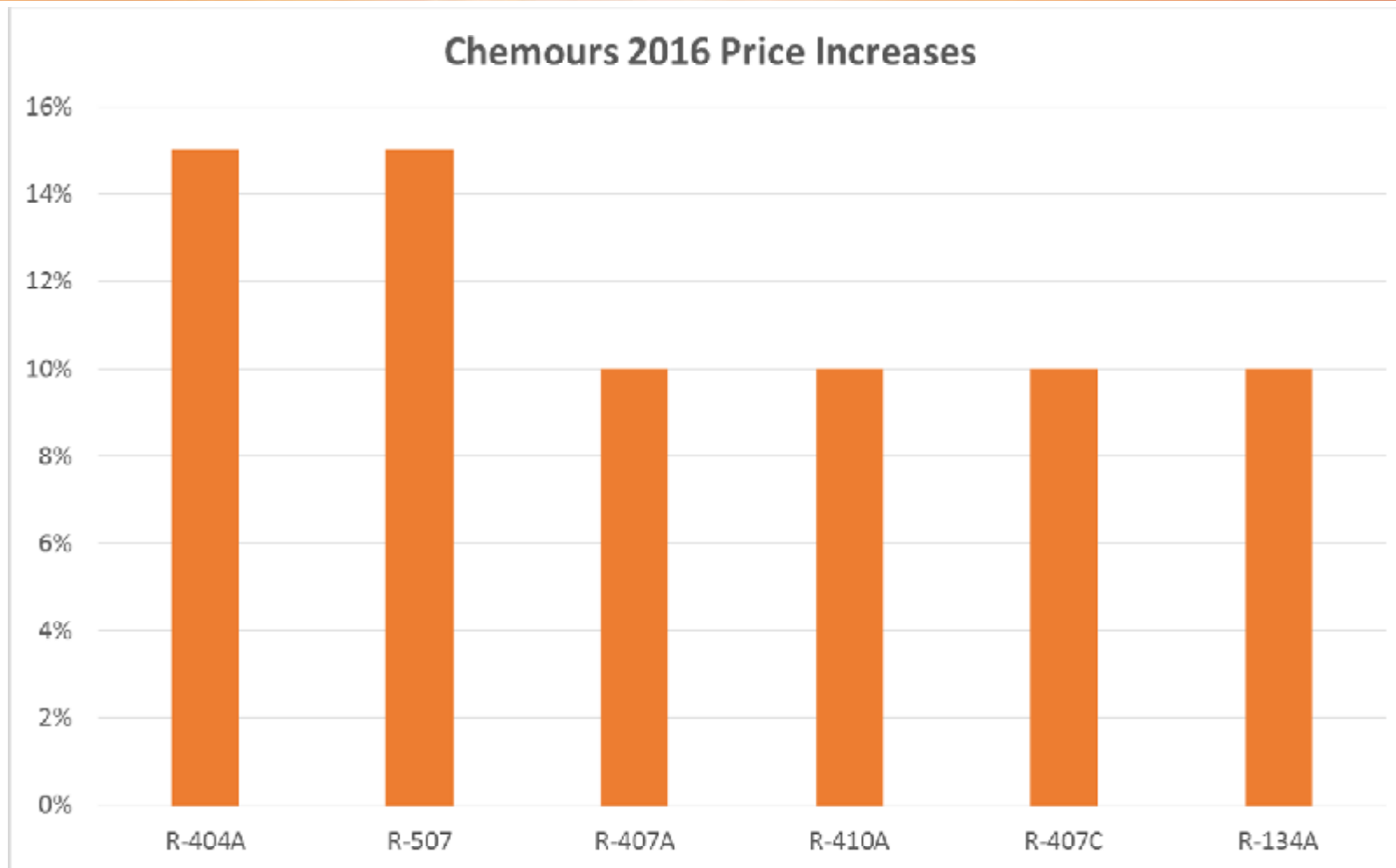

# Time to get off the bottle?

Can we afford to continue with synthetics?



**REARRANGE  
DECKCHAIRS  
AND  
IGNORE  
SINKING**



# Going Natural

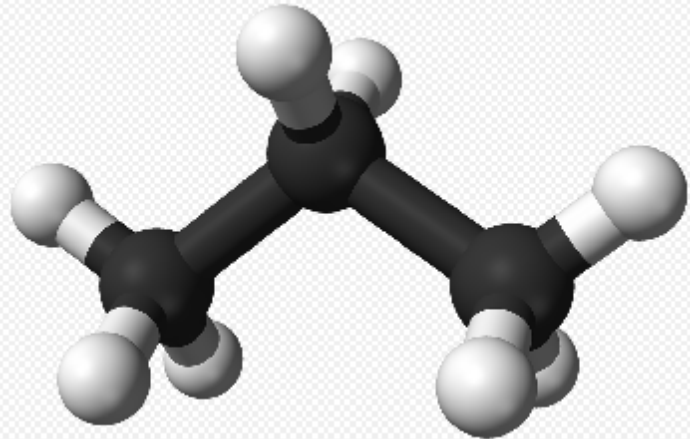
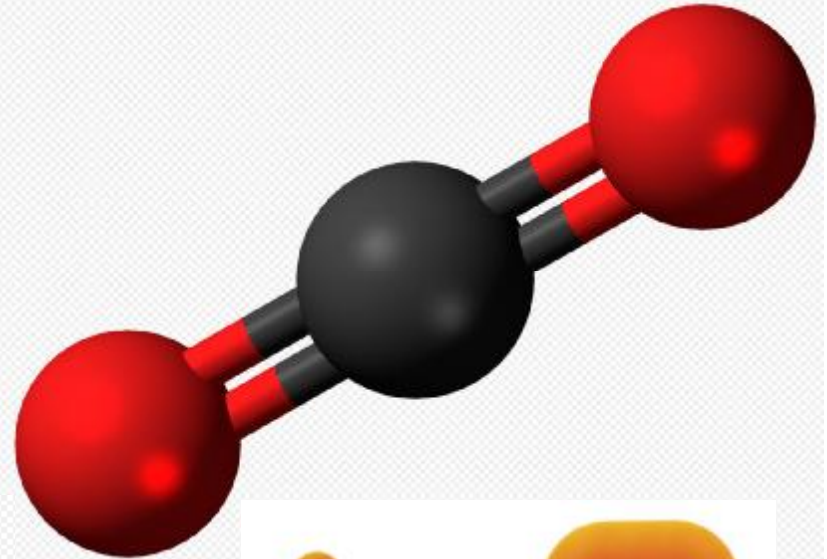
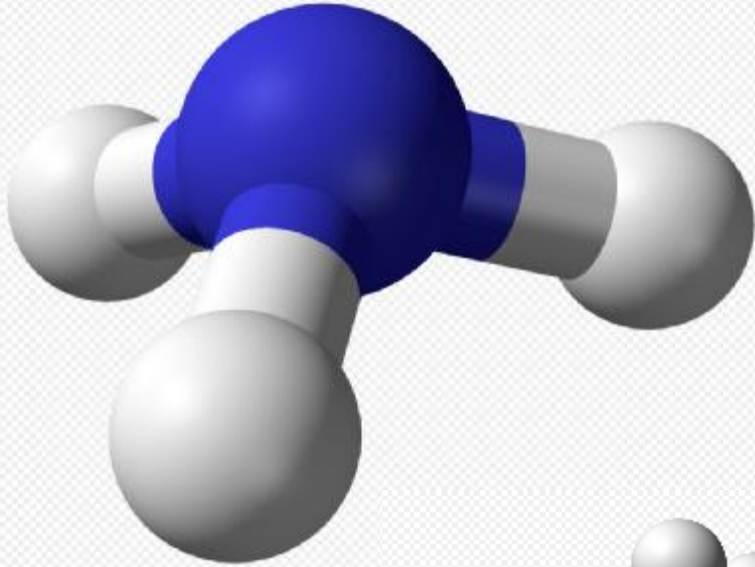

# Loads of New(-ish) Equipment

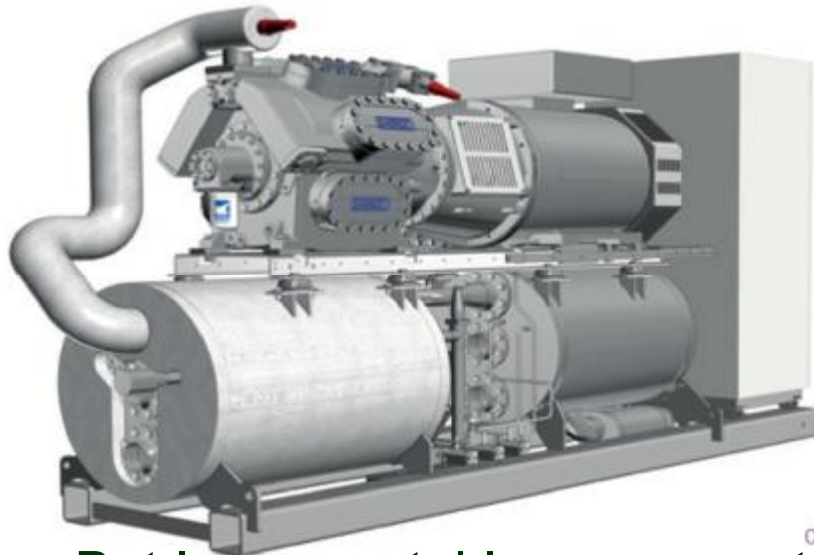

ChillPAC 108



SABlight air-cooled chiller

But: Incremental Improvements

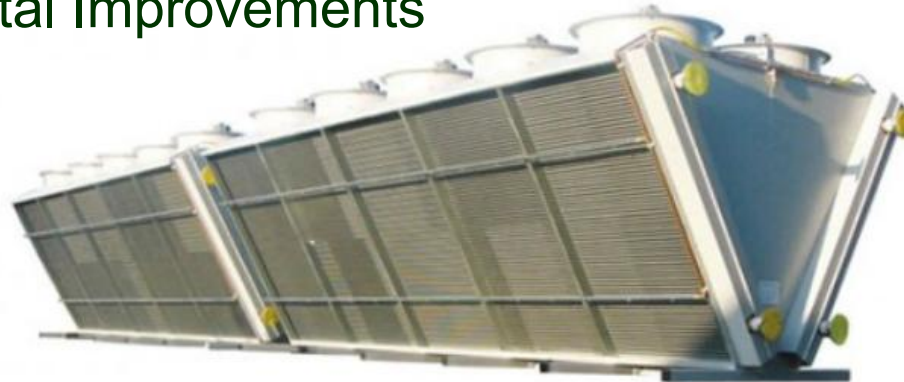

# Glycol Chiller Heat Pump Combination

## Somerston Winery California

- Glycol cooling
- Hot water
- Adiabatic cooler for hot weather
- 3 year payback



# Finding your Sweet Spot

Your Refrigeration System

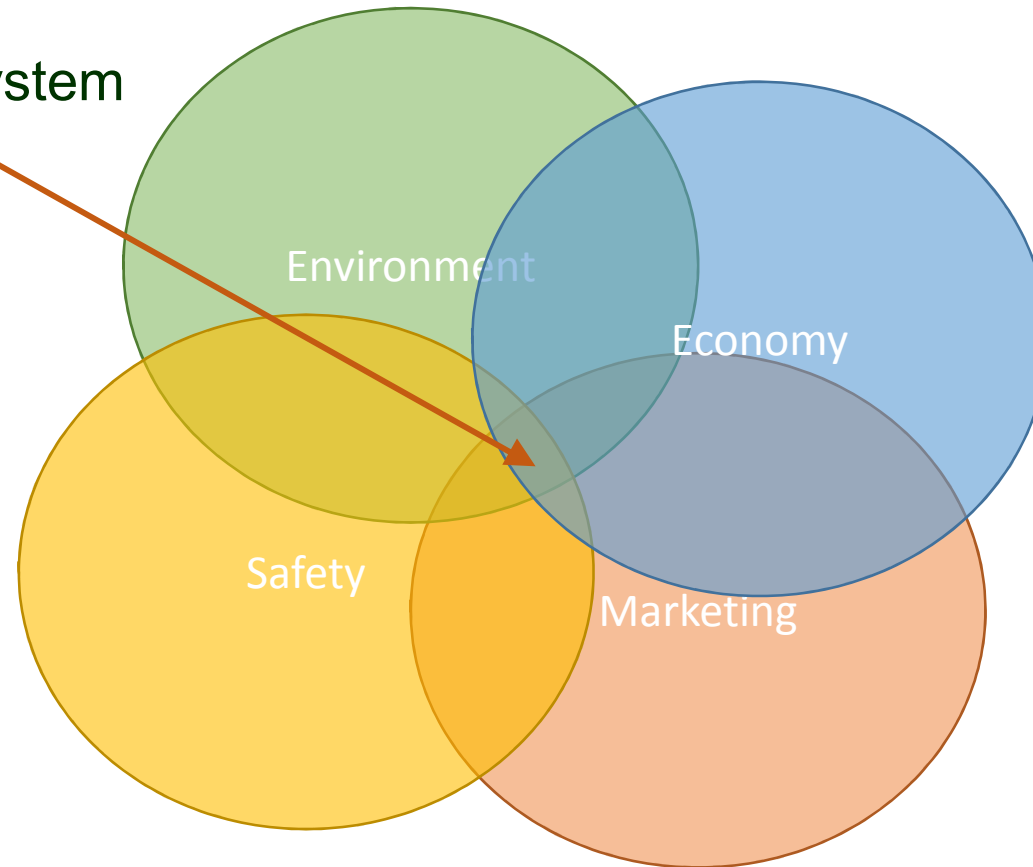

# Electricity Consumption

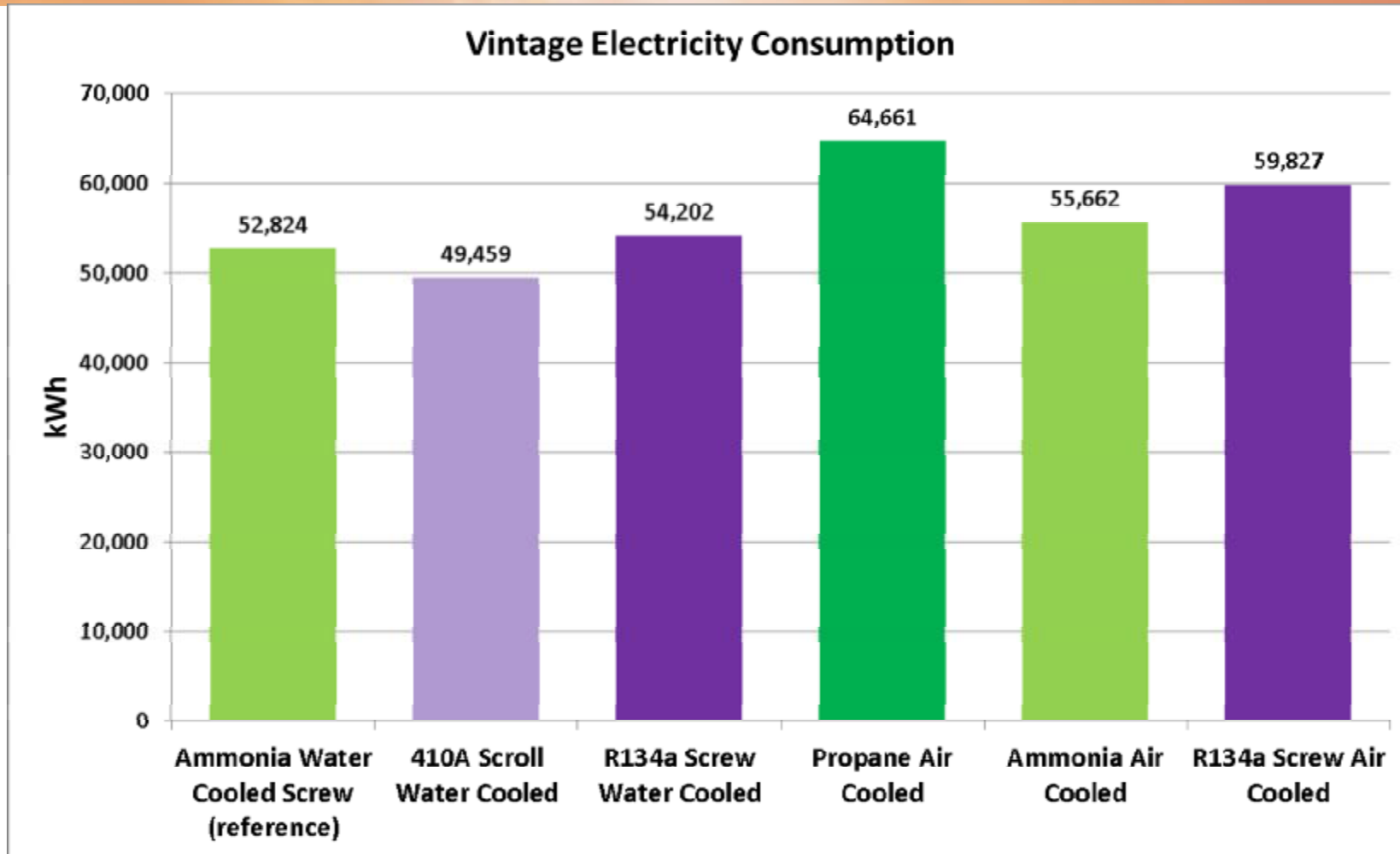

# Carbon Pricing – does it matter?

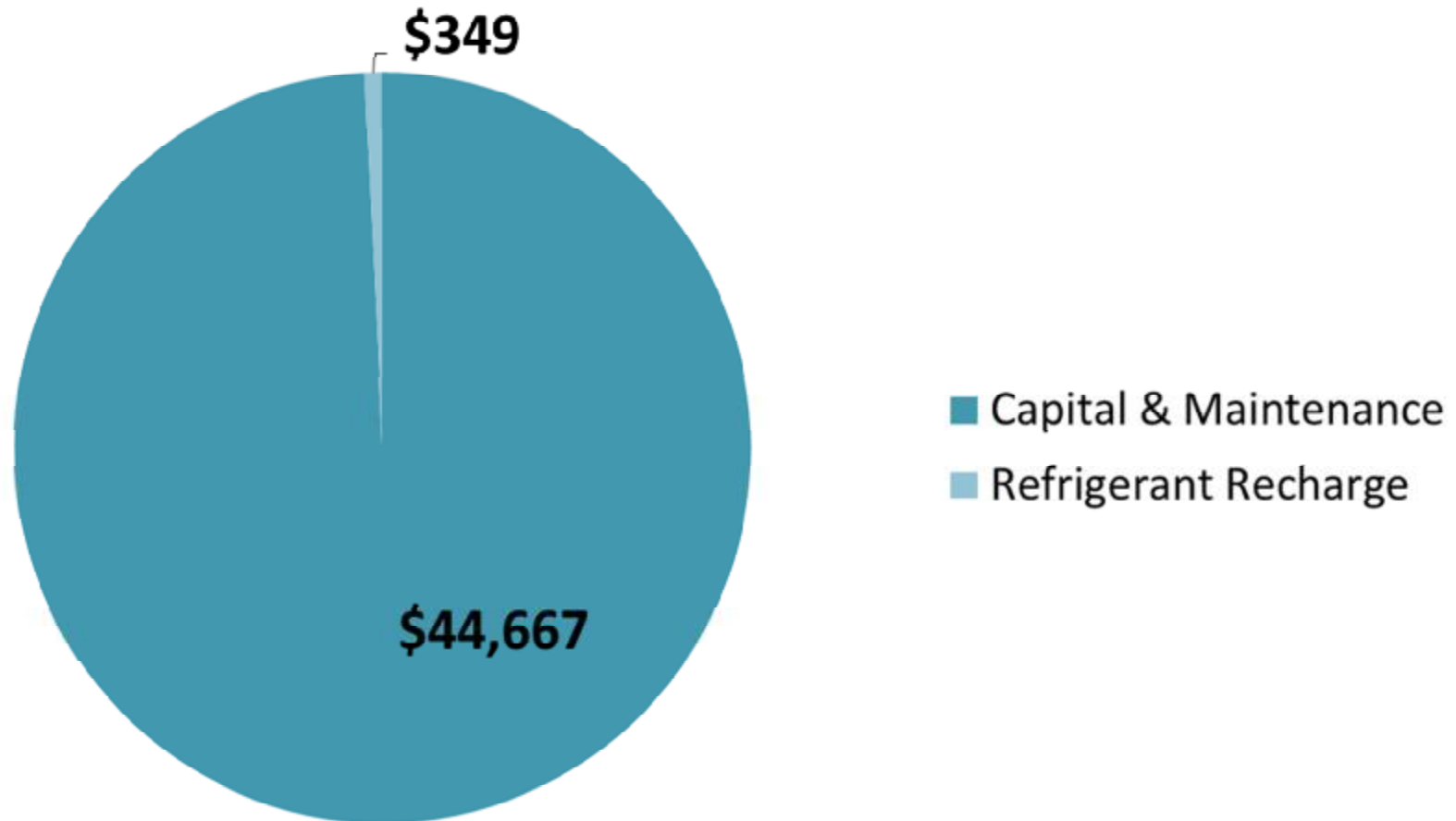

# Natural versus Synthetic – Marketing Value?

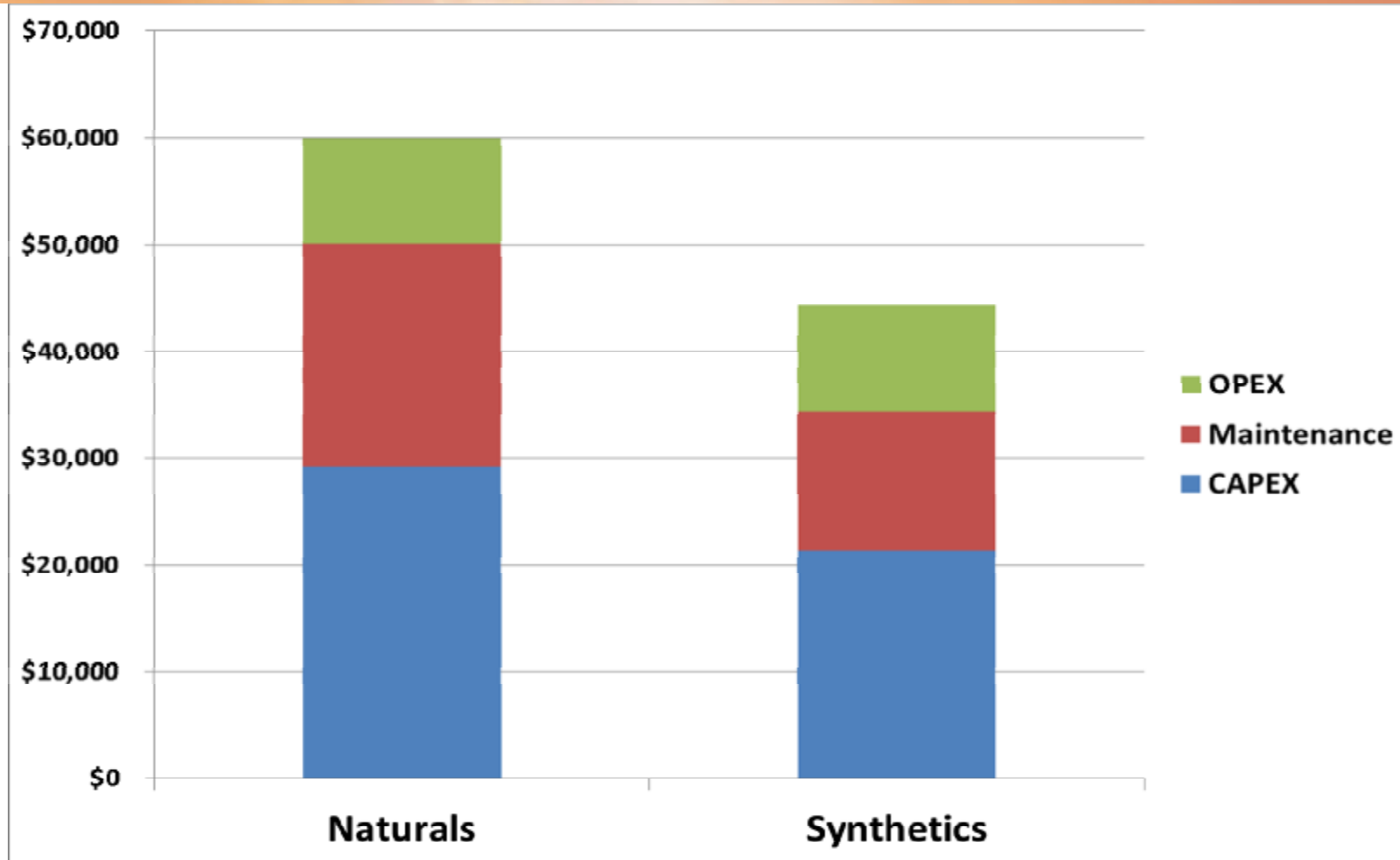

# Bolder Solutions: Heat Pumps?

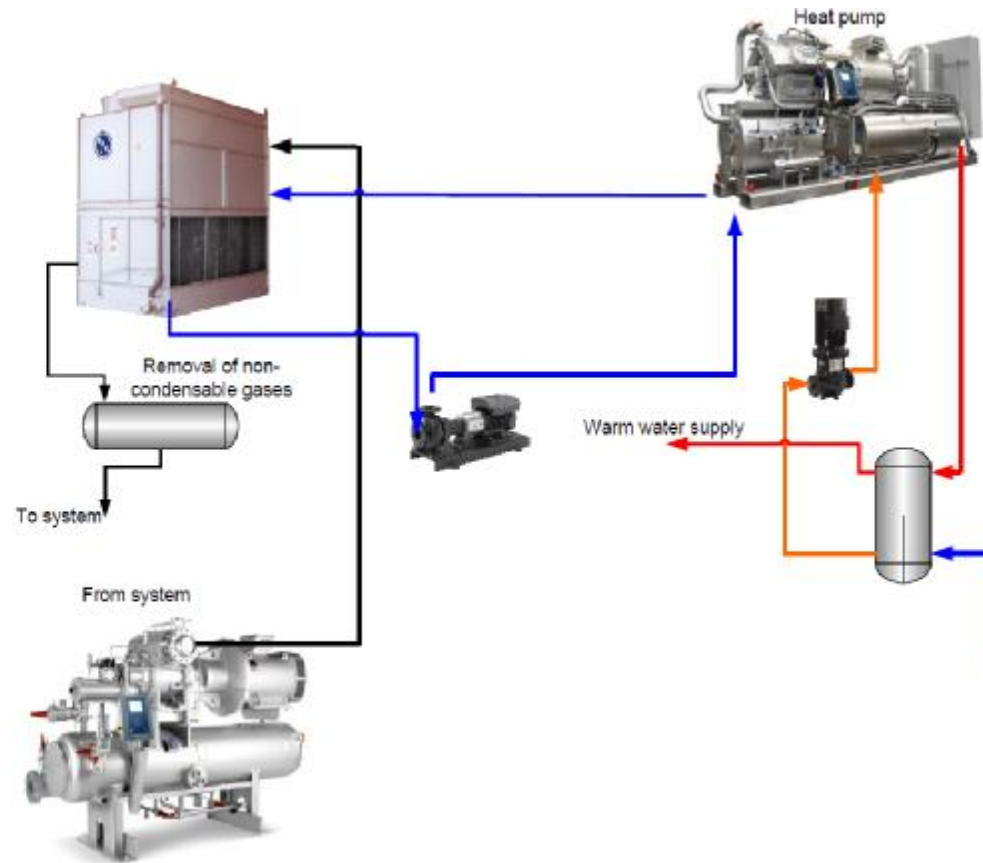

**But does heat demand match refrigeration demand?**

# Solar/Heat Pumps/Boilers – Total Cost of Ownership

TOTAL ANNUAL COST OF OWNERSHIP - HOT WATER UPGRADE

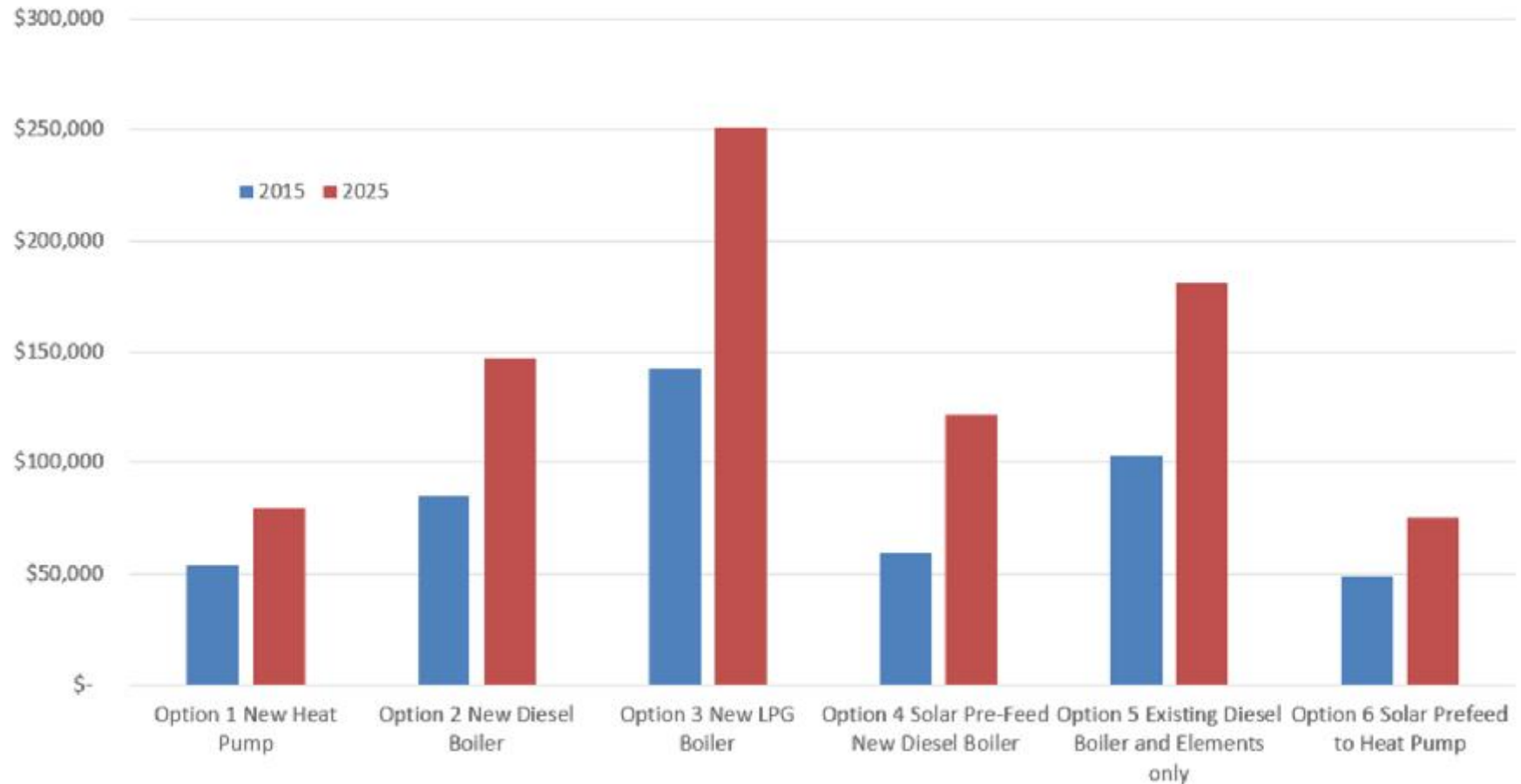

## Thinking inside the box – vine prunings



Better to burn vine trimmings than to spend money on a heat pump or solar equipment?

18 month payback...(Courtesy Yealands Wine Group)

# Summary

- Synthetics are reaching their “use-by” date
- Plenty of incremental development in chillers and equipment
  - Lower charges for ammonia
  - Adiabatic coolers
  - Natural solutions becoming more ubiquitous at small scale
- Carbon pricing isn’t driving synthetic refrigerant replacement – yet, so don’t replace your chilling plant until it wears out
- Natural refrigerants might help your marketing story
- Heat pumps – still difficult to make the business case, especially for retrofit, might work in combination with solar
- Biomass heating solutions might be a better hot water solution than heat pumps

**You need a holistic view!**

# What will you do?

Yealands Estate has replaced its LPG-fired boiler with two wood-burning boilers to produce the heat it needs for winemaking, with the financial support of the Energy Efficiency and Conservation Authority. The first project of its type in New Zealand, the vineyard is burning off-cuts from its own grapevines as opposed to using regular wood .

Based on the 2011 harvest, Yealands Estate says LPG consumption has dropped by more than 466,000kWh, resulting in a saving of \$168,000 in just one year.

Because burning vine prunings is carbon neutral, the company also looks set to cut CO<sub>2</sub> emissions by 161 tonnes a year, further enhancing its green credentials in export markets. Burning biomass for energy is considered carbon neutral because the amount of carbon released when it is burnt is equivalent to the amount of carbon removed from the atmosphere as it grew.

## Costs

- Two 250kW Central Boiler™ Pallet Burners cost \$187,600 to install. At current production levels, they will pay for themselves in less than 18 months
- Purchasing a baler for the back of the tractor was the extent of the capital outlay. The estimated cost of gathering and baling the prunings is just \$2,200 a year, as most of the equipment would have been used anyway